

International Laminated Power Transformers

- 115V/230V Dual Primary
- Class B (130°C) Insulation
- 3500Vrms HiPot (Pri:Sec)
- UL94V-0 Flammability
- UL506 (E79781)
- Non-Inherently Limited
- 2.5VA to 56VA
- TUV (810/89)
- VDE 0551, 0806
- UL1411 (E138028)
- Recognized Insulation System for custom designs.

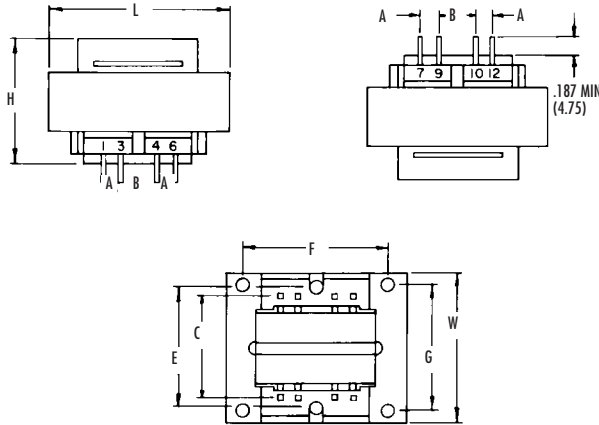

Dimensions Inches (mm)

VA (SIZE)	L	W	H	A	B	C	MOUNTING			MTG. SCREWS	PIN SQUARE	LBS (KG.)
							E	F	G			
2.5 (41.3)	1.625 (41.3)	1.313 (33.3)	1.125 (28.6)	.200 (5.1)	.250 (6.4)	1.000 (25.4)	1.063 (27.0)	—	—	2X#4 (2X M3)	.025 (.635)	.25 (.11)
5.0 (41.3)	1.625 (41.3)	1.313 (33.3)	1.375 (34.9)	.200 (5.1)	.400 (10.2)	1.000 (25.4)	1.063 (27.0)	—	—	2X#4 (2X M3)	.025 (.635)	.37 (.17)
10.0 (47.6)	1.875 (47.6)	1.563 (39.7)	1.375 (34.9)	.200 (5.1)	.400 (10.2)	1.140 (29.0)	1.250 (31.8)	—	—	2X#4 (2X M3)	.036 (.914)	.53 (.24)
20.0 (57.1)	2.250 (57.1)	1.875 (47.6)	1.625 (41.3)	.400 (10.2)	.400 (10.2)	1.460 (37.1)	1.500 (38.1)	—	—	2X#4 (2X M3)	.036 (.914)	.90 (.41)
30.0 (66.7)	2.625 (66.7)	2.188 (55.6)	1.563 (39.7)	.550 (14.0)	.275 (7.0)	1.680 (42.7)	1.680 (42.7)	—	2.19 (55.6)	1.75 (44.5)	.045 (1.14)	1.15 (.52)
56.0 (76.2)	3.000 (76.2)	2.500 (63.5)	1.845 (46.9)	.600 (15.2)	.300 (7.6)	1.900 (48.3)	—	2.50 (63.5)	2.00 (50.8)	4X#6 (4X M5)	.045 (1.14)	1.70 (.77)

Packaging:

Size	Tube	Tray
2.5	10	40
5.0	9	54
10.0	8	40

Size	Tube	Tray
20.0	8	40
30.0	8	20
56.0	8	16

PART NO.	VA (SIZE)	SECONDARY			
		PARALLEL CONNECTED		SERIES CONNECTED	
		AC VOLTS	RMS AMPS	AC VOLTS	RMS AMPS
PL2.5-10-130B	2.5	5.0	0.50	10.0 CT	0.25
PL5.0-10-130B	5.0	5.0	1.00	10.0 CT	0.50
PL10-10-130B	10.0	5.0	2.00	10.0 CT	1.00
PL20-10-130B	20.0	5.0	4.00	10.0 CT	2.00
PL30-10-130B	30.0	5.0	6.00	10.0 CT	3.00
PL56-10-130B	56.0	5.0	11.20	10.0 CT	5.60
PL2.5-12-130B	2.5	6.3	0.40	12.6 CT	0.20
PL5.0-12-130B	5.0	6.3	0.80	12.6 CT	0.40
PL10-12-130B	10.0	6.3	1.60	12.6 CT	0.80
PL20-12-130B	20.0	6.3	3.20	12.6 CT	1.60
PL30-12-130B	30.0	6.3	4.80	12.6 CT	2.40
PL56-12-130B	56.0	6.3	8.80	12.6 CT	4.40
PL2.5-16-130B	2.5	8.0	0.30	16.0 CT	0.15
PL5.0-16-130B	5.0	8.0	0.62	16.0 CT	0.31
PL10-16-130B	10.0	8.0	1.25	16.0 CT	0.62
PL20-16-130B	20.0	8.0	2.50	16.0 CT	1.25
PL30-16-130B	30.0	8.0	3.80	16.0 CT	1.90
PL56-16-130B	56.0	8.0	7.00	16.0 CT	3.50
PL2.5-20-130B	2.5	10.0	0.24	20.0 CT	0.12
PL5.0-20-130B	5.0	10.0	0.50	20.0 CT	0.25
PL10-20-130B	10.0	10.0	1.00	20.0 CT	0.50
PL20-20-130B	20.0	10.0	2.00	20.0 CT	1.00
PL30-20-130B	30.0	10.0	3.00	20.0 CT	1.50
PL56-20-130B	56.0	10.0	5.60	20.0 CT	2.80
PL2.5-24-130B	2.5	12.0	0.20	24.0 CT	0.10
PL5.0-24-130B	5.0	12.0	0.42	24.0 CT	0.21
PL10-24-130B	10.0	12.0	0.84	24.0 CT	0.42
PL20-24-130B	20.0	12.0	1.66	24.0 CT	0.83
PL30-24-130B	30.0	12.0	2.50	24.0 CT	1.25
PL56-24-130B	56.0	12.0	4.66	24.0 CT	2.33
PL2.5-28-130B	2.5	14.0	0.18	28.0 CT	0.09
PL5.0-28-130B	5.0	14.0	0.36	28.0 CT	0.18
PL10-28-130B	10.0	14.0	0.72	28.0 CT	0.36
PL20-28-130B	20.0	14.0	1.44	28.0 CT	0.72
PL30-28-130B	30.0	14.0	2.12	28.0 CT	1.06
PL56-28-130B	56.0	14.0	4.00	28.0 CT	2.00
PL2.5-36-130B	2.5	18.0	0.14	36.0 CT	0.07
PL5.0-36-130B	5.0	18.0	0.28	36.0 CT	0.14
PL10-36-130B	10.0	18.0	0.56	36.0 CT	0.28
PL20-36-130B	20.0	18.0	1.12	36.0 CT	0.56
PL30-36-130B	30.0	18.0	1.64	36.0 CT	0.82
PL56-36-130B	56.0	18.0	3.12	36.0 CT	1.56

Schematics

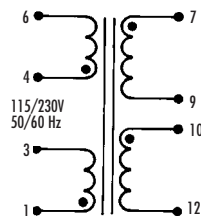

TAMURA CORPORATION

43352 Business Park Drive. | P.O. Box 892230 Temecula, CA 92589-2230 | www.tamuracorp.com
 USA | Japan | United Kingdom | Hong Kong
 Tel: 800-872-6624 | Tel: 81 (0)3 3978-2111 | Tel: 44 (0) 1380 731 700 | Tel: 852-2389-4321
 Fax: 909-676-9482 | Fax: 81 (0)3 3923-0230 | Fax: 44 (0) 1380 731 702 | Fax: 852-2341-9689

Laminated Power Transformers

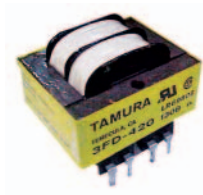

- 115V Single Primary
- 115/230 Dual Primary
- Class B (130°C) Insulation
- 2,500 Vrms Hi-Pot (Pri:Sec)
- 500 & 1KVrms Hi-Pot (Sec:Sec)
- UL94V-0 Flammability
- Recognized Insulation System for custom designs.
- 1.1VA to 12VA
- Inherently and Non-inherently Limited Product
- Class II & III Product
- UL1585 (E96720/E95844)
- UL506 (E79781/E91239)

TAMURA PART NUMBER		SECONDARY RMS RATING				SIZE	CLASS
Single 115V	Dual 115/230V	PARALLEL CONNECTED		SERIES CONNECTED			
		AC	RMS	AC	RMS		
3FS-210	3FD-210	5.0	0.220	10.0 CT	0.110	2	II
3FS-310	3FD-310	5.0	0.500	10.0 CT	0.250	3	II
3FS-410	3FD-410	5.0	1.200	10.0 CT	0.600	4	II
3FS-510	3FD-510	5.0	2.400	10.0 CT	1.200	5	II
3FS-212	3FD-212	6.3	0.180	12.6 CT	0.090	2	II
3FS-312	3FD-312	6.3	0.400	12.6 CT	0.200	3	II
3FS-412	3FD-412	6.3	1.000	12.6 CT	0.500	4	II
3FS-512	3FD-512	6.3	2.000	12.6 CT	1.000	5	II
3FS-216	3FD-216	8.0	0.140	16.0 CT	0.070	2	II
3FS-316	3FD-316	8.0	0.300	16.0 CT	0.150	3	II
3FS-416	3FD-416	8.0	0.800	16.0 CT	0.400	4	II
3FS-516	3FD-516	8.0	1.600	16.0 CT	0.800	5	II
3FS-220	3FD-220	10.0	0.110	20.0 CT	0.055	2	II
3FS-320	3FD-320	10.0	0.240	20.0 CT	0.120	3	II
3FS-420	3FD-420	10.0	0.600	20.0 CT	0.300	4	II
3FS-520	3FD-520	10.0	1.200	20.0 CT	0.600	5	II
3FS-224	3FD-224	12.0	0.090	24.0 CT	0.045	2	II
3FS-324	3FD-324	12.0	0.200	24.0 CT	0.100	3	II
3FS-424	3FD-424	12.0	0.500	24.0 CT	0.250	4	II
3FS-524	3FD-524	12.0	1.000	24.0 CT	0.500	5	II
3FS-228	3FD-228	14.0	0.080	28.0 CT	0.040	2	II
3FS-328	3FD-328	14.0	0.170	28.0 CT	0.085	3	II
3FS-428	3FD-428	14.0	0.400	28.0 CT	0.200	4	II
3FS-528	3FD-528	14.0	0.840	28.0 CT	0.420	5	II
3FS-236	3FD-236	18.0	0.060	36.0 CT	0.030	2	III
3FS-336	3FD-336	18.0	0.130	36.0 CT	0.065	3	III
3FS-436	3FD-436	18.0	0.340	36.0 CT	0.170	4	III
3FS-536	3FD-536	18.0	0.700	36.0 CT	0.350	5	III
3FS-248	3FD-248	24.0	0.046	48.0 CT	0.023	2	III
3FS-348	3FD-348	24.0	0.100	48.0 CT	0.050	3	III
3FS-448	3FD-448	24.0	0.250	48.0 CT	0.125	4	III
3FS-548	3FD-548	24.0	0.500	48.0 CT	0.250	5	III

1. -TF suffix for inherently limited product version
2. -1 suffix for 1kV Sec:Sec isolation product version

Schematics

3FS PRIMARY INPUT CONNECTIONS

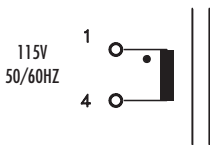

3FD PRIMARY INPUT CONNECTIONS

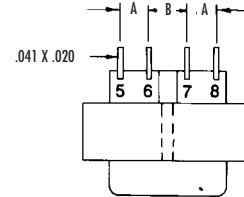
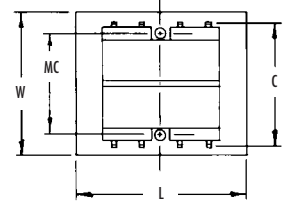
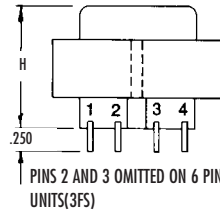
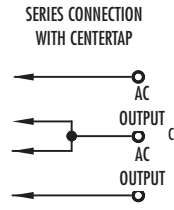
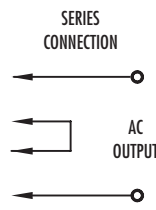
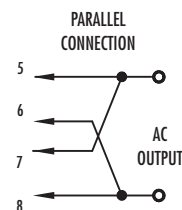
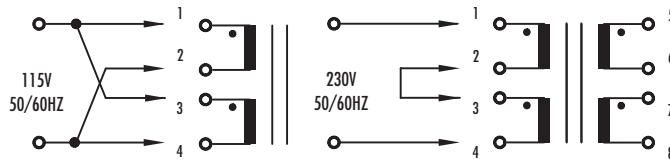

Dimensions Inches (mm)

SIZE	VA ²	L	W	H	MC	A	B	C	LB.
2	1.1	1.44 (36.57)	1.23 (31.24)	1.00 (25.40)	-	.250 (6.35)	.250 (6.35)	1.200 (30.48)	0.17
3	2.4	1.44 (36.57)	1.23 (31.24)	1.26 (32.00)	-	.250 (6.35)	.250 (6.35)	1.200 (30.48)	0.25
4	6	6	1.69 (42.93)	1.36 (34.54)	1.0625 ¹ (26.92)	.250 (6.35)	.350 (8.89)	1.280 (32.51)	0.44
5	12	12	1.97 (50.04)	1.63 (41.40)	1.5 ¹ (38.10)	.300 (7.62)	.400 (10.16)	1.41 (35.81)	0.70

Note 1: Clearance hole for 4-40 x 1 3/8" nylon mtg. screws.
 Note 2: Ratings based on 115V nominal input.
 All dimensions are ± 0.02 (0.50) unless otherwise noted.

Packaging:

Size	Tube	Tray
2	10	80
3	10	60

Size	Tube	Tray
4	10	50
5	10	50

TAMURA CORPORATION

43352 Business Park Drive. | P.O. Box 892230 Temecula, CA 92589-2230 | www.tamuracorp.com

USA
Tel: 800-872-6624
Fax: 909-676-9482

Japan
Tel: 81 (0)3 3978-2111
Fax: 81 (0)3 3923-0230

United Kingdom
Tel: 44 (0) 1380 731 700
Fax: 44 (0) 1380 731 702

Hong Kong
Tel: 852-2389-4321
Fax: 852-2341-9689